

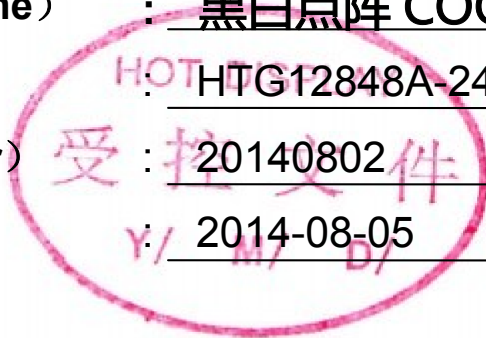

HTG12848A-24N-28K08

产品名称 (Product name) : 黑白点阵 COG
 型号 (Model) : HTG12848A-24N-28K08
 编号 (Part number) : 20140802
 日期 (Date) : 2014-08-05



深圳市鑫洪泰电子科技有限公司 Shenzhen Hot Display Technology Co.,Ltd		
编制 Prepared by	审核 Checked by	核准 Approved by

编码: QR-R-011 A/0

序号:

Rev.	Descriptions	Date
01	Prelimiay Release	2014-08-05

Table of Content

1. Bsaic Specifications	-----	3
1.1 Display Specifications	-----	3
1.2 Mechanical Specifications	-----	3
1.3 Circuit Diagram	-----	3
1.4 Terminal Function	-----	4
1.5 Product Outline	-----	5
1.6 Schematic Diagram	-----	6
2. Absolute Maximum Ratings	-----	7
3. Electrical Characteristics	-----	7
3.1 DC Characteristics	-----	7
3.2 LED Backlight Circuit	-----	7
3.3 AC Characteristics	-----	8
3.4 Reset Timing	-----	11
4. Function specifications	-----	11
4.1 The Parallel Interface	-----	11
4.2 The Serial Interface	-----	12
4.3 Basic Setting	-----	12
4.4 Resetting the LCD module	-----	12
4.5 Display Memory Map	-----	13
4.6 Display Commands	-----	14
4.7 Basic Operating Sequence	-----	15
5. Inspection Standards	-----	16
6. Handling Precautions	-----	17
6.1 Mounting method	-----	17
6.2 Cautions of LCD handling and cleaning	-----	17
6.3 Caution against static charge	-----	17
6.4 Packaging	-----	17
6.5 Caution for operation	-----	17
6.6 Storage	-----	17
6.7 Safety	-----	17
7 Packaging specifications	-----	18



1. Basic Specifications

1.1 Display Specifications

- 1>LCD Display Mode : STN-Bule, Negative, Transmissive
- 2>Viewing Angle : 6H
- 3>Driving Method : 1/33 Duty, 1/6 Bias
- 4>Backlight : Without LED

1.2 Mechanical Specifications

- 1>Outline Dimension : 78.7x 35.9 x 2.8mm (See attached Outline Drawing for Details)

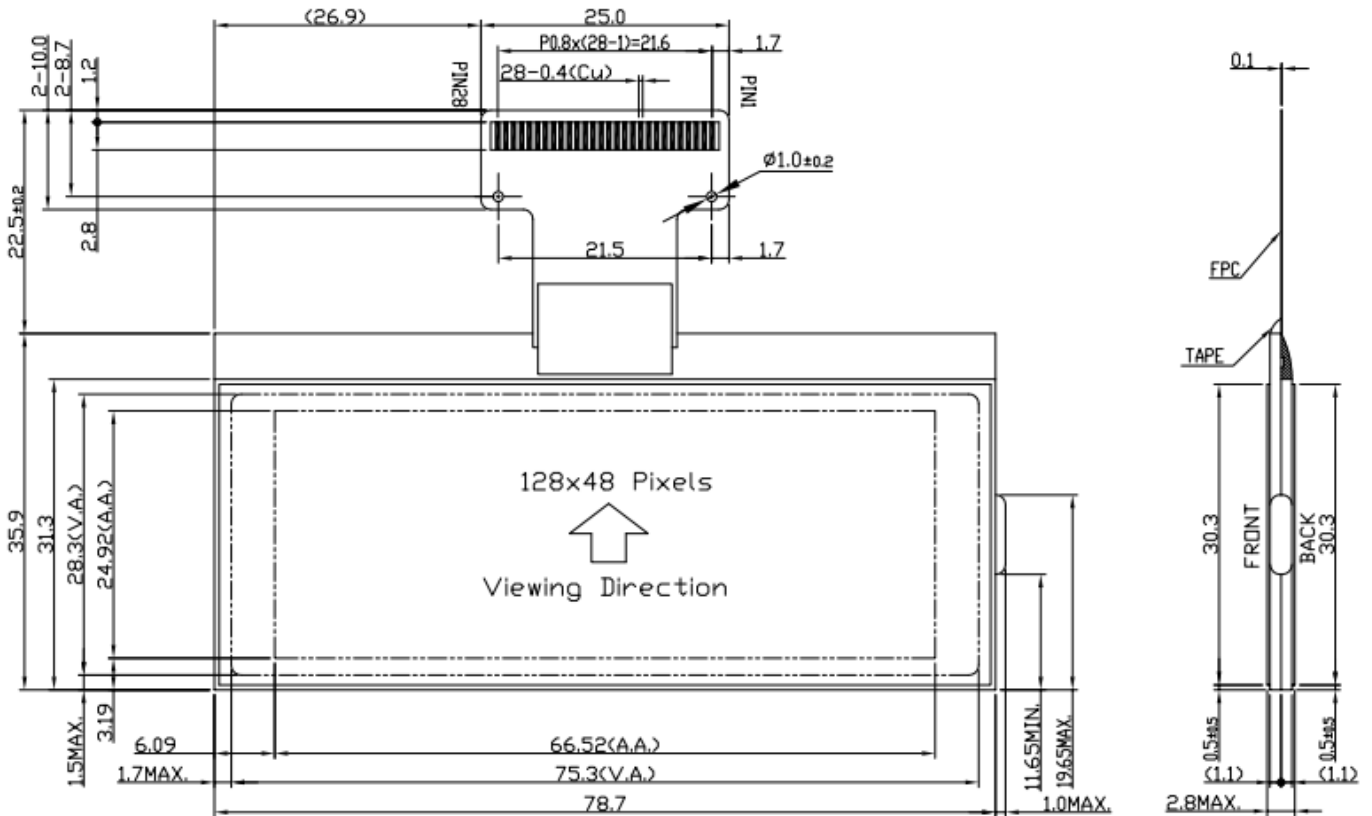

1.3 Circuit Diagram

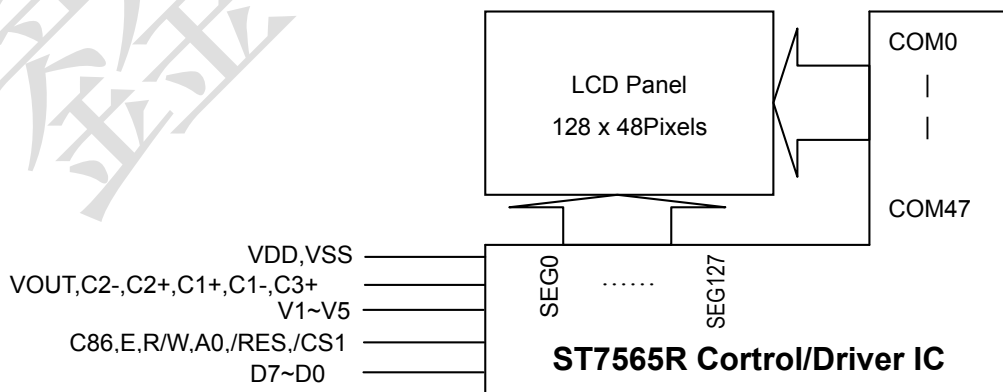

1.4 Terminal Function

Pin No.	Pin Name	Function
1	VDD	Power supply
2	P/S	This pin configures the interface to be parallel mode or serial mode. P/S = "H": Parallel data input/output. P/S = "L": Serial data input.
3	C86	This is the MPU interface selection pin. C86 = "H": 6800 Series MPU interface. C86 = "L": 8080 Series MPU interface.
4~8	V5~V1	This is a multi-level power supply for the liquid crystal drive. The voltage Supply applied is determined by the liquid crystal cell, and is changed through the use of a resistive voltage divided or through changing the impedance using an op. amp. Voltage levels are determined based on Vss, and must maintain the relative magnitudes shown below. $V1 \geq V2 \geq V3 \geq V4 \geq V5$
9	C2+	When internal DC-DC voltage converter is used, external capacitor is connected between these pins.
10	C2-	
11	C1+	
12	C1-	
13	C3+	
14	VOUT	Positive voltage supply pin of the chip.
15	VSS	Negative power supply,0V
16~23	D7~D0	8bit Date bus, D7 : serial data input (SI) ; D6 : the serial clock input (SCL)
24	E	<ul style="list-style-type: none"> When connected to 8080 series MPU, this pin is treated as the "/RD" signal of the 8080 MPU and is LOW-active. The data bus is in an output status when this signal is "L". When connected to 6800 series MPU, this pin is treated as the "E" signal of the 6800 MPU and is HIGH-active. This is the enable clock input terminal of the 6800 Series MPU.
25	R/W	When R/W = "H": Read. When R/W = "L": Write.
26	A0	This is connect to the least significant bit of the normal MPU address bus, and it determines whether the data bits are data or command. A0 = "H":Indicates that D0 to D7 are display data. A0 = "L": Indicates that D0 to D7 are control data
27	/RES	Reset
28	/CS1	Chip selection input

1.5 Product Outline

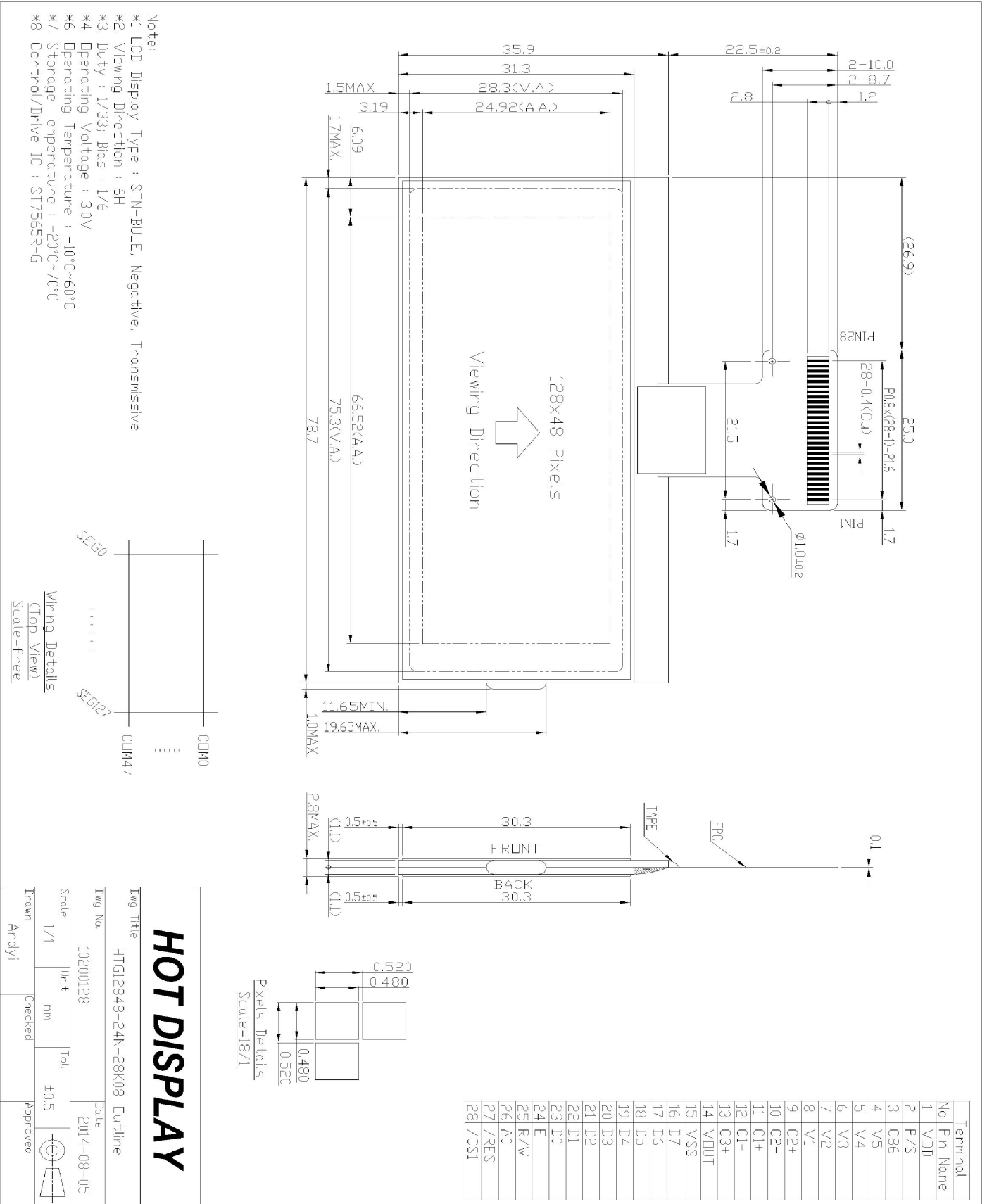

HOT DISPLAY

Dwg Title: HTG12848-24N-28K08 DUTLINE

Dwg No: 10200128 Date: 2014-08-05

Scale: 1/1 Unit: mm Tol: \pm 0.5

Drawn: [Signature] Checked: [Signature] Approved: [Signature]

1.6 Schematic Diagram

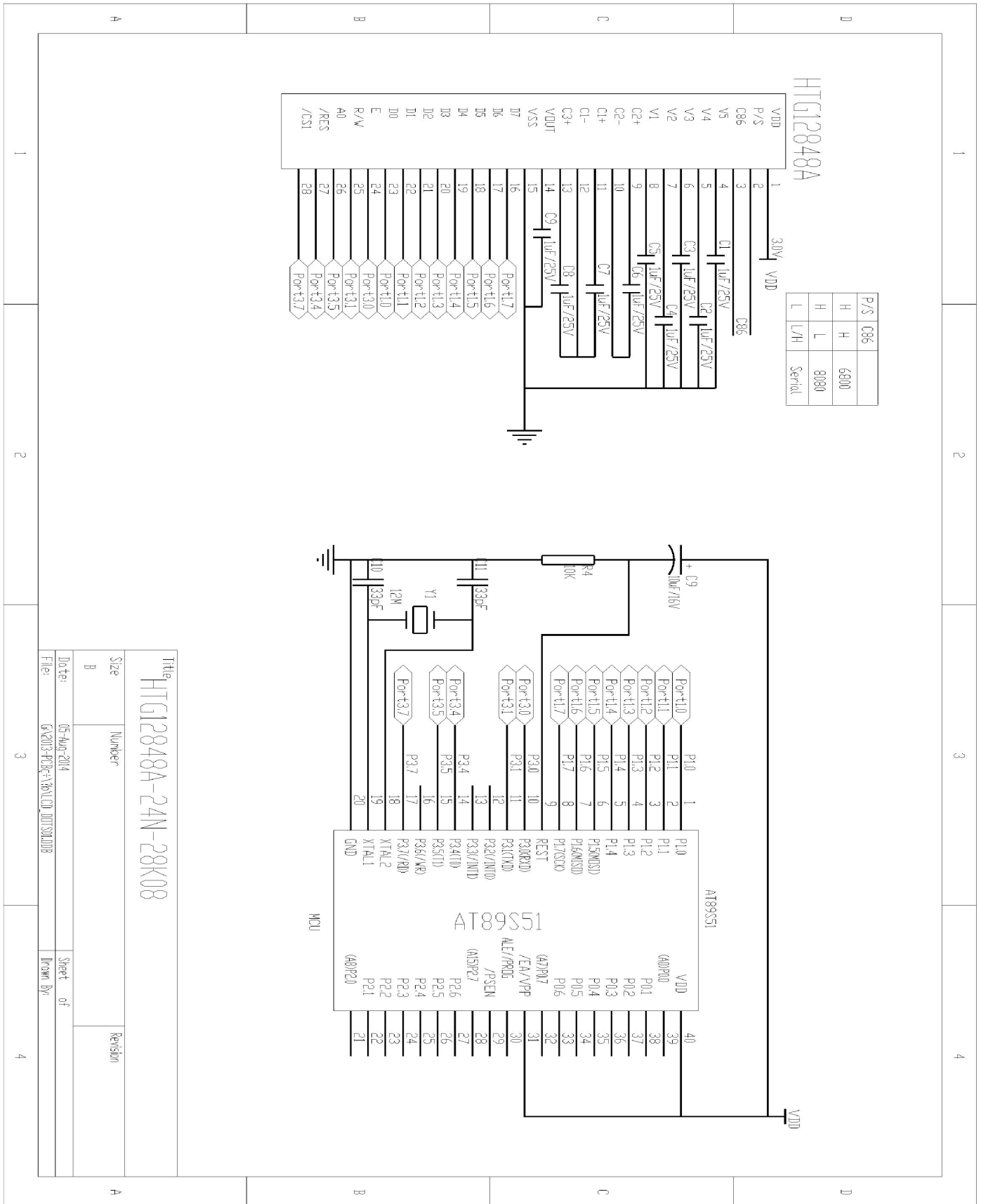

2. Absolute Maximum Ratings

Items	Symbol	MIN.	MAX.	Unit	Condition
Supply Voltage	V _{DD}	-0.3	+3.6	V	V _{SS} = 0V
Input Voltage	V _{IN}	-0.3	V _{DD} +0.3	V	V _{SS} = 0V
Operating Temperature	T _{OP}	-20	+70	°C	No Condensation
Storage Temperature	T _{st}	-30	+80	°C	No Condensation

3. Electrical Characteristics

3.1 DC Characteristics

 V_{SS} = 0V, Top = 25°C

Items	Symbol	MIN.	TYP.	MAX.	Unit	Condition
Operating Voltage	V _{DD}	3.0	3.3	3.6	V	V _{DD}
Input High Voltage	V _{IH}	0.8 x V _{DD}	-	V _{DD}	V	/CS1,/RES,A0,E , R/W,D0~D7,C86
Input Low Voltage	V _{IL}	V _{SS}	-	0.2 x V _{DD}	V	
Output High Voltage	V _{OH}	0.8 x V _{DD}	-	V _{DD}	V	D0~D7
Output Low Voltage	V _{OL}	V _{SS}	-	0.2 x V _{DD}	V	D0~D7
Operation Current	I _{OP}	100	-	220	μA	V _{DD} =3.0V
Sleep mode	I _{DD}	-	0.1	4	μA	Ta=25°C
Standby mode	I _{DD}	-	5	10	μA	Ta=25°C

3.2 LED Backlight Circuit

 V_{SS} = 0V, Top = 25°C

Items	Symbol	MIN.	TYP.	MAX.	Unit	Condition
Forward Voltage	V _f BLA	-	-	-	V	V _{DD}
Forward Current	I _f BLA	-	-	-	mA	V _{DD}

3.3 AC Characteristics

3.3.1 8080 Mode System Bus Timing

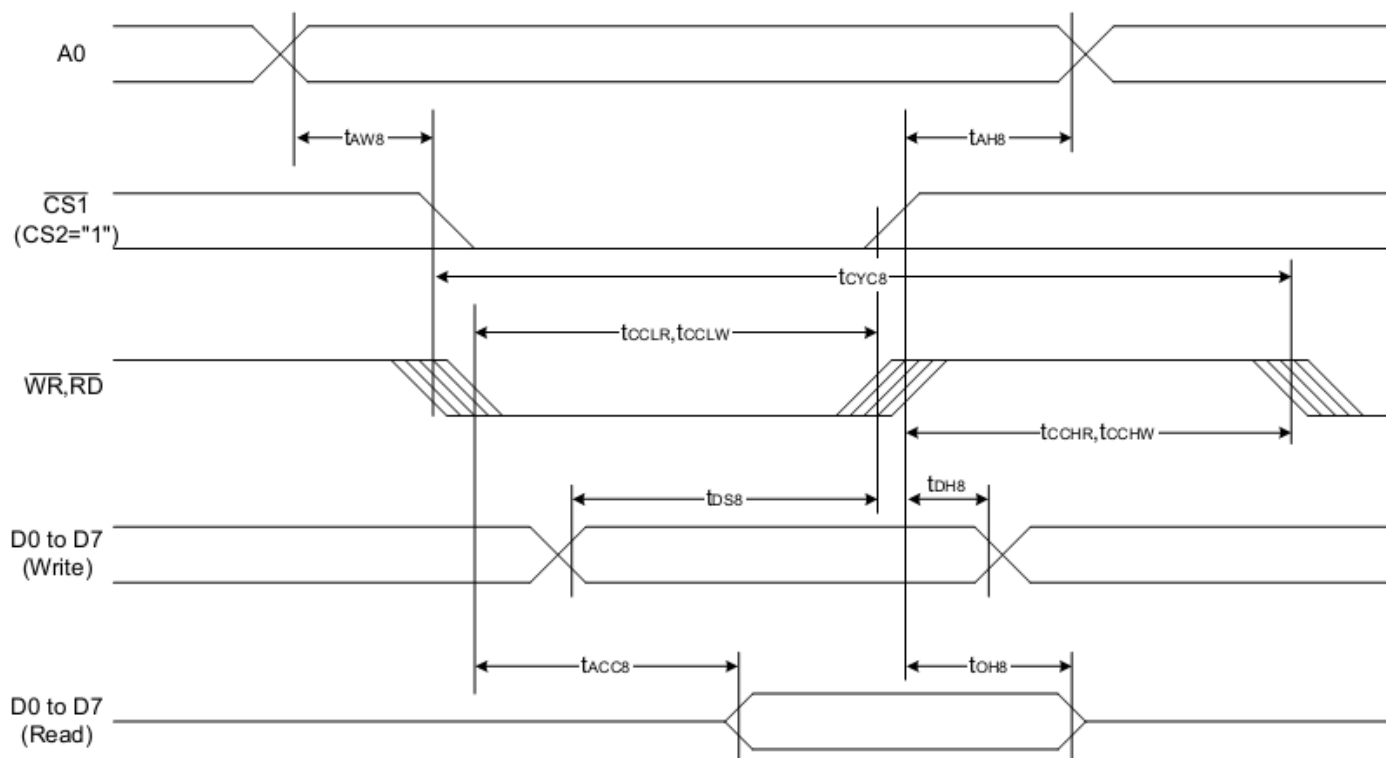

V_{ss} = 0V, T_{op} = 25°C

Items	Symbol	MIN.	TYP.	MAX.	Unit	Condition
System cycle time	Tcyc8	500	-	-	ns	-
Address setup time(A0)	Taw8	10	-	-	ns	-
Address hold time(A0)	Tah8	10	-	-	ns	-
Control Low Pulse wide(/RD)	tcclr	275	-	-	ns	-
Control Low Pulse wide(/WR)	tcclw	275	-	-	ns	-
Control High Pulse wide(/RD)	tcchr	225	-	-	ns	-
Control High Pulse wide(/WR)	tcchw	225	-	-	ns	-
Data setup time	Tds8	50	-	-	ns	-
Data hold time	Tdh8	10	-	-	ns	-
/RD access time(*a)	Tacc8	-	-	200	ns	-
Output disable time(*a)	Tch8	15	-	150	ns	-

Note:

*a. all timing is using 20% and 80% of V_{DD} as the reference.

3.3.2 6800 Mode System Bus Timing

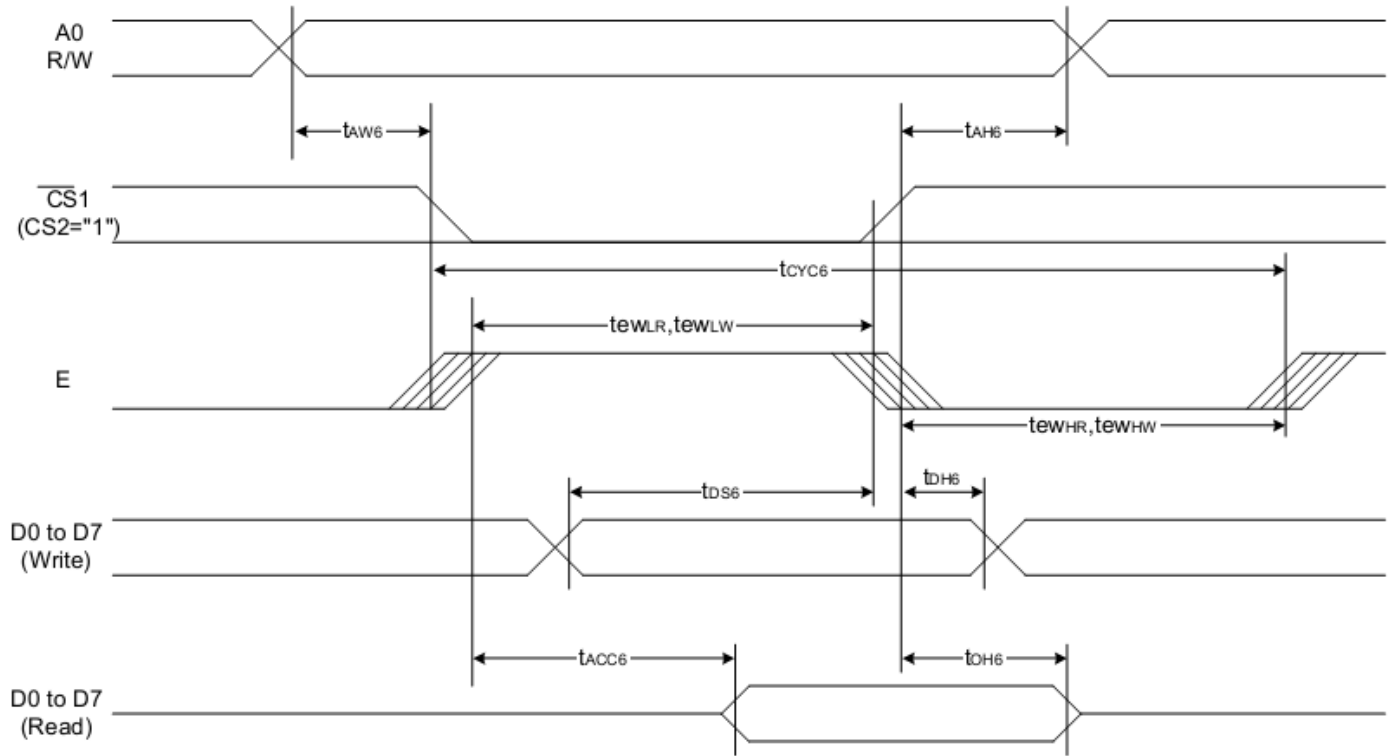

V_{ss} = 0V, T_{op} = 25°C

Items	Symbol	MIN.	TYP.	MAX.	Unit	Condition
System cycle time	Tcyc6	500	-	-	ns	-
Address setup time(A0)	Taw6	10	-	-	ns	-
Address hold time(A0)	Tah6	10	-	-	ns	-
Control Low Pulse wide(/RD)	tcclr	275	-	-	ns	-
Control Low Pulse wide(/WR)	tcclw	275	-	-	ns	-
Control High Pulse wide(/RD)	tcchr	225	-	-	ns	-
Control High Pulse wide(/WR)	tcchw	225	-	-	ns	-
Data setup time	Tds6	50	-	-	ns	-
Data hold time	Tdh6	10	-	-	ns	-
/RD access time(*a)	Tacc6	-	-	200	ns	-
Output disable time(*a)	Tch6	15	-	150	ns	-

Note:

*a. all timing is using 20% and 80% of VDD as the reference.

*b. CL = 100pF

3.3.3 Serial Mode Interface

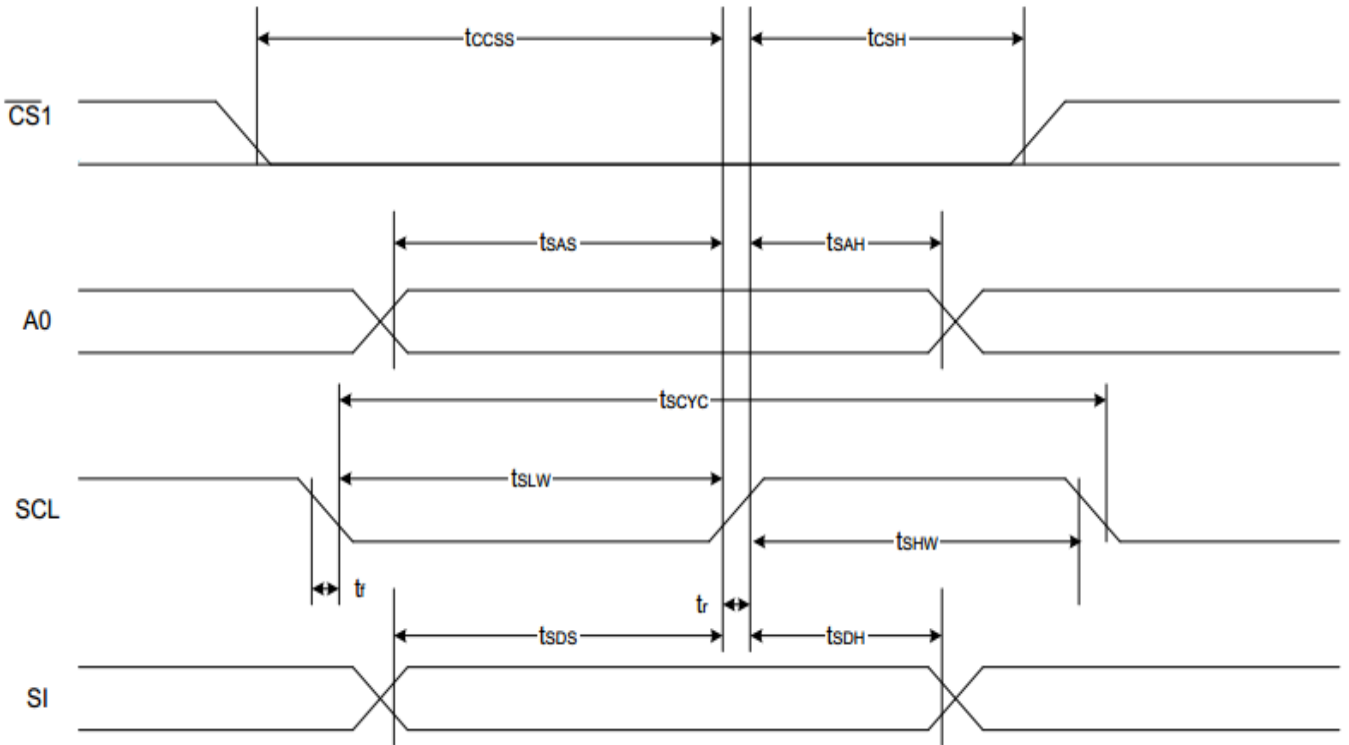

(VDD = 3.3V, Ta = -30 to 85°C)

Item	Signal	Symbol	Condition	Rating		Units
				Min.	Max.	
4-line SPI Clock Period	SCL	T_{scyc}		50	—	ns
SCL "H" pulse width		T_{shw}		25	—	
SCL "L" pulse width		T_{slw}		25	—	
Address setup time	A0	T_{sas}		20	—	
Address hold time		T_{sah}		10	—	
Data setup time	SI	T_{sds}		20	—	
Data hold time		T_{sdh}		10	—	
CS-SCL time	CS	T_{css}		20	—	
CS-SCL time		T_{csh}		40	—	

3.4 Reset Timing

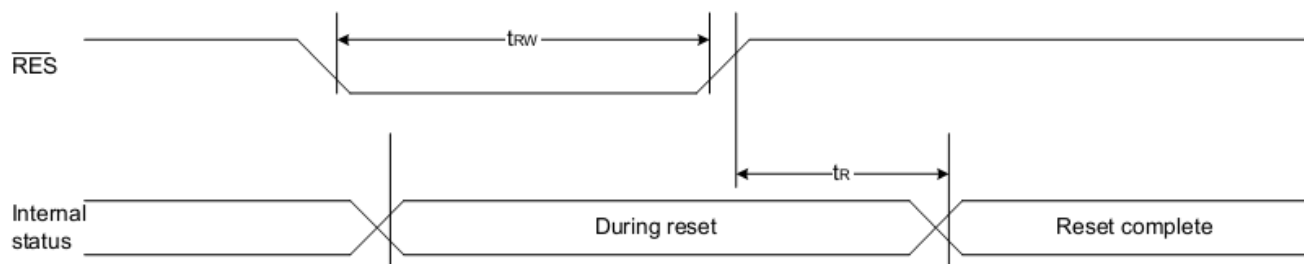

(VDD = 3.3V, Ta = -30 to 85°C)

Item	Signal	Symbol	Condition	Rating			Units
				Min.	Typ.	Max.	
Reset time		tR		—	—	1.0	us
Reset "L" pulse width	/RES	tRW		1.0	—	—	us

Table 37

(VDD = 2.7V, Ta = -30 to 85°C)

Item	Signal	Symbol	Condition	Rating			Units
				Min.	Typ.	Max.	
Reset time		tR		—	—	2.0	us
Reset "L" pulse width	/RES	tRW		2.0	—	—	us

Table 38

(VDD = 1.8V, Ta = -30 to 85°C)

Item	Signal	Symbol	Condition	Rating			Units
				Min.	Typ.	Max.	
Reset time		tR		—	—	3.0	us
Reset "L" pulse width	/RES	tRW		3.0	—	—	us

Note:

*a. all timing is using 20% and 80% of VDD as the reference.

4. Function specifications

4.1 The Parallel Interface

Shared	6800 Mode		8080 Mode		Function
A0	R/W	E	/RD	/WR	
H	H	H	L	H	Reads the display data
H	L	H→L	H	L → H	Writes the display data
L	H	H	L	H	Status read
L	L	H→L	H	L → H	Write Command data

4.2 The Serial Interface

When the serial interface has been selected then when the chip is in active state the serial data input(SI) and the serial clock(SCL) can be received. The serial data is read from the serial data input pin in the rising edge of the serial clock . When "A0"="H", the data is display data, and when "A0"="L", the data is command.

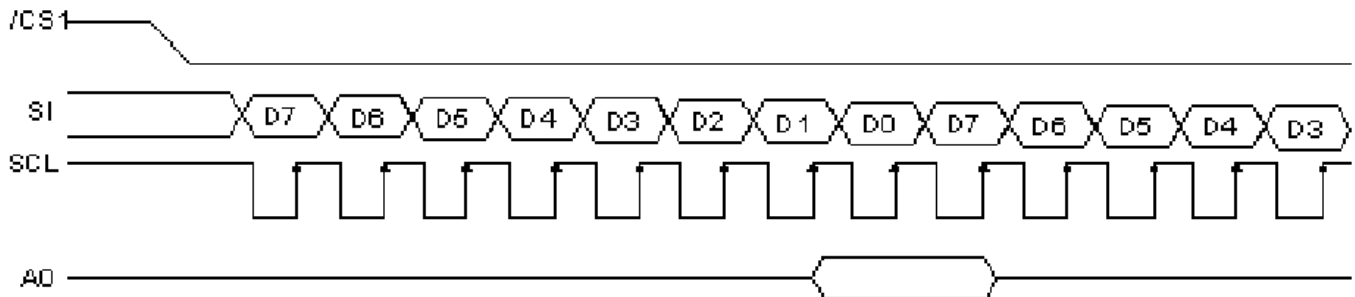

4.3 Basic Setting

To drive the LCD module correctly and provide normally display, please use the following setting

- 1> ADC = 0 (normal)
- 2> SHL select = 1(reverse)
- 3> LCD Bias Select = 1/9
- 4> Initial Display Line = 0
- 5> Entire Display ON/OFF = OFF(normal)
- 6> Reverse Display ON/OFF = OFF(normal)
- 7> Set Power Control Set:
Voltage follower = ON, voltage converter = ON, Voltage regulator = ON
- 8> Display ON/OFF = ON

4.4 Resetting the LCD module

The LCD module should be initialized by using /RES terminal.

While turning on the VDD and VSS power supply, maintain /RES terminal at LOW level, After the Power supply stabilized, release the reset terminal(/RES = High)

4.5 Display Memory Map

Page address	data	LCD Display (front view)	
0	D0 : D7		
1	D0 : D7		
2	D0 : D7		
3	D0 : D7		
4	D0 : D7		
5	D0 : D7		
Column Address		00h	7f h

4.6 Display Commands

No.	Instrctions	Code												Function
		A0	/RD	/WR	D7	D6	D5	D4	D3	D2	D1	D0		
1	Display ON/OFF	0	1	0	1	0	1	0	1	1	1	1	DON	DON=0,display off DON=1,display on
2	Display start line set	0	1	0	0	1	Display start address						Set the display RAM display start line address	
3	Set Page Address	0	1	0	1	0	1	1	Page address					Set the display RAM Page address
4	Ser Column Address (Upper-4 bits)	0	1	0	0	0	0	1	Col. Add					Set the upper-4-bit of column address counter
	Ser Column Address (Lower-4 bits)	0	1	0	0	0	0	0	Col. Add					Set the low-4-bit of column address counter
5	Read Staus	0	0	1	Status				0	0	0	0		Read the status data
6	Write Display Data	1	1	0	Write Data									Write data into the display RAM
7	Read Display Data	1	0	1	Read Data									Read data from the display RAM
8	ADC Select	0	1	0	1	0	1	0	0	0	0	0	ADC	Set the display RAM address SEG output Correspondence ADC = 0,Normal. ADC = 1,Reverse
9	Normal/Reverse Display	0	1	0	1	0	1	0	0	1	1		REV	REV = 0, Normal REV = 1, Reverse
10	Entire Display ON/OFF	0	1	0	1	0	1	0	0	1	0		EON	EON = 0, Normal EON = 1, Entire display ON
11	Set LCD Bias	0	1	0	1	0	1	0	0	0	1		BIAS	Bias = 0, 1/9 Bias Bias = 1, 1/7 Bias
12	Set Read-Modify-Write	0	1	0	1	1	1	0	0	0	0	0		Enter the "Read-Modify-Write" mode
13	Reset Read-Modify-Write	0	1	0	1	1	1	0	1	1	1	0		Clear the "Read-Modify-Write" mode
14	Reset	0	1	0	1	1	1	0	0	0	1	0		Resets the LCD module
15	SHL S elect	0	1	0	1	1	0	0	SHL	*	*	*		Set the COM scanning direction SHL = 0, Normal SHL = 1, Flipped in y-direction * = don't care terms
16	Power Control Set	0	1	0	0	0	1	0	1	VC	VR	VF		Set the power circuit operation mode VF : LCD Supply Voltage Follower VR : LCD Supply Voltage Regulator VF : LCD Supply Voltage Converter (1 = ON, 0 = OFF)
17	Regulator Resistor Select	0	1	0	0	0	1	0	0	Ratio				Set the built-in resistor ratio (Rb/Ra)
18	Electronic volume mode set	0	1	0	1	0	0	0	0	0	0	1		Set reference voltage mode
	Electronic volume register set	0	1	0	*	*	Electronic Control value						Set reference voltage register	
19	Power Save		-	-	-	-	-	-	-	-	-	-		Compound instruction Display OFF + Entire Display ON
20	NOP	0	1	0	1	1	1	0	0	0	1	1		Non-operation command

Note:

*a. For the details of the Display Commands, please refer to ST7565R data sheet

4.7 Basic Operating Sequence

Initialization Sequence

	Code Function										Note	
	A0	D7	D6	D5	D4	D3	D2	D1	D0	hex		
Turn on Power Supply VDD & VSS While maintaining /RES at LOW	-	-	-	-	-	-	-	-	-	-	-	
Wait until power supply is stabilized	-	-	-	-	-	-	-	-	-	-	-	
Release the /RES Reset Signal (/RES = High)	-	-	-	-	-	-	-	-	-	-	-	See AC Characteristics section for timing details
LCD Bias = 1/9	0	1	0	1	0	0	0	1	0	0	A2H	LCD Characteristics
ADC = Normal	0	1	0	1	0	0	0	0	0	0	A0H	No flip on x-direction (SEG)
SHL = Reverse	0	1	1	0	0	1	0	0	0	0	C8H	Flip on y- direction (COM)
Initial Display Line = 0	0	0	1	0	0	0	0	0	0	0	40H	i.e. Display RAM "Page 0-D0" Matched to top line of the LCD
Power Control Voltage Follower = OFF Voltage Regulator = OFF Voltage Converter = ON Delay 50ms	0	0	0	1	0	1	1	0	0	0	2CH	Turn on the internal Voltage Converter and wait until VOUT stable
	-	-	-	-	-	-	-	-	-	-	-	
Power Control Voltage Follower = OFF Voltage Regulator = OFF Voltage Converter = ON Delay 50ms	0	0	0	1	0	1	1	1	0	0	2EH	Turn on the internal Voltage Regulator and wait until VOUT stable
	-	-	-	-	-	-	-	-	-	-	-	
Power Control Voltage Follower = OFF Voltage Regulator = OFF Voltage Converter = ON Delay 50ms	0	0	0	1	0	1	1	1	1	0	2FH	Turn on the internal Voltage Follower and wait until VOUT stable
	-	-	-	-	-	-	-	-	-	-	-	
Regulator Resistor Select	0	0	0	1	0	0	1	0	1	0	25H	Set the built-in resistor ratio to middle
Set Reference Voltage Mode	0	1	0	0	0	0	0	0	1	0	81H	Set to the middle of the range it may be adjusted For achieving the best display contrast
Set Reference Voltage Resistor	0	0	0	1	0	0	0	1	0	0	22H	
Display ON	0	1	0	1	0	1	1	1	1	1	AFH	Turn on the LCD display
Set Page Address = 0	0	1	0	1	1	0	0	0	0	0	B0H	Specify the display data RAM page address to 00H
Set Column Address (Upper -4bit = 0)	0	0	0	0	1	0	0	0	0	0	10H	Specify the display data RAM column address to 00H
Set Column Address (Lower-4bit =4)	0	0	0	0	0	0	1	0	0	0	01H	
Write Display Data	1	Display Data									-	
Write Other Display Data												

5. Inspection Standards

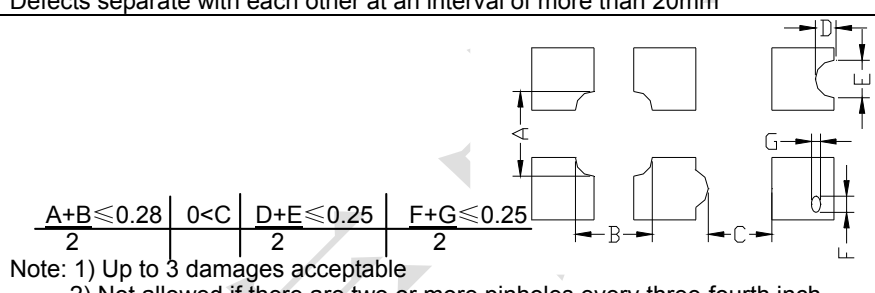
Item	Criterion for defects	Defect type
1) Display on inspection	(1) Non display (2) Vertical line is deficient (3) Horizontal line is deficient (4) Cross line is deficient	Major
2) Black / White spot	Size Φ (mm) Acceptable number $\Phi \leq 0.3$ Ignore (note) $0.3 < \Phi \leq 0.45$ 3 $0.45 < \Phi \leq 0.6$ 1 $0.6 < \Phi$ 0	Minor
3) Black / White line	Length (mm) Width (mm) Acceptable number $L \leq 10$ $W \leq 0.03$ Ignore $5.0 \leq L \leq 10$ $0.03 < W \leq 0.04$ 3 $5.0 \leq L \leq 10$ $0.04 < W \leq 0.05$ 2 $1.0 \leq L \leq 10$ $0.05 < W \leq 0.06$ 2 $1.0 \leq L \leq 10$ $0.06 < W \leq 0.08$ 1 $L \leq 10$ $0.08 < W$ follows 2) point defect Defects separate with each other at an interval of more than 20mm	Minor
4) Display pattern	 <p>Note: 1) Up to 3 damages acceptable 2) Not allowed if there are two or more pinholes every three-fourth inch.</p>	Minor
5) Spot-like contrast irregularity	Size Φ (mm) Acceptable Number $\Phi \leq 0.7$ Ignore (note) $0.7 < \Phi \leq 1.0$ 3 $1.0 < \Phi \leq 1.5$ 1 $1.5 < \Phi$ 0 Note: 1) Conformed to limit samples. 2) Intervals of defects are more than 30mm.	Minor
6) Bubbles in polarizer	Size Φ (mm) Acceptable Number $\Phi \leq 0.4$ Ignore (note) $0.4 < \Phi \leq 0.65$ 2 $0.65 < \Phi \leq 1.2$ 1 $1.2 < \Phi$ 0	Minor
7) Scratches and dent on the polarizer	Scratches and dent on the polarizer shall be in the accordance with “2) Black/white spot”, and “3) Black/White line”.	Minor
8) Stains on the surface of LCD panel	Stains which cannot be removed even when wiped lightly with a soft cloth or similar cleaning.	Minor
9) Rainbow color	No rainbow color is allowed in the optimum contrast on state within the active area.	Minor
10) Viewing area encroachment	Polarizer edge or line is visible in the opening viewing area due to polarizer shortness or sealing line.	Minor
11) Bezel appearance	Rust and deep damages that are visible in the bezel are rejected.	Minor
12) Defect of land surface contact	Evident crevices that are visible are rejected.	Minor
13) Parts mounting	(1) Failure to mount parts (2) Parts not in the specifications are mounted (3) For example: Polarity is reversed, HSC or TCP falls off.	Minor
14) Part alignment	(1) LSI, IC lead width is more than 50% beyond pad outline. (2) More than 50% of LSI, IC leads is off the pad outline.	Minor
15) Conductive foreign matter (solder ball, solder hips)	(1) $0.45 < \Phi$, $N \geq 1$ (2) $0.3 < \Phi \leq 0.45$, $N \geq 1$, Φ : Average diameter of solder ball (unit: mm) (3) $0.5 < L$, $N \geq 1$, L : Average length of solder chip (unit: mm)	Minor
16) Bezel flaw	Bezel claw missing or not bent	Minor
17) Indication on name plate (sampling indication label)	(1) Failure to stamp or label error, or not legible.(all acceptable if legible) (2) The separation is more than 1/3 for indication discoloration, in which the characters can be checked.	Minor

6. Handling Precautions

6.1 Mounting method

A panel of LCD module made by our company consists of two thin glass plates with polarizers that easily get damaged. And since the module is so constructed as to be fixed by utilizing fitting holes in the printed circuit board (PCB), extreme care should be used when handling the LCD modules.

6.2 Cautions of LCD handling and cleaning

When cleaning the display surface, use soft cloth with solvent (recommended below) and wipe lightly.

- Isopropyl alcohol
- Ethyl alcohol
- Trichlorotrifluoroethane

Do not wipe the display surface with dry or hard materials that will damage the polarizer surface.

Do not use the following solvent:

- Water
- Ketene
- Aromatics

6.3 Caution against static charge

The LCD module uses C-MOS LSI drivers. So we recommend you:

Connect any unused input terminal to V_{dd} or V_{ss} . Do not input any signals before power is turned on, and ground your body, work/assembly areas, assembly equipment to protect against static electricity.

6.4 Packaging

- Module employs LCD elements, and must be treated as such. Avoid intense shock and falls from a height.
- To prevent modules from degradation, do not operate or store them exposed direct to sunshine or high temperature/humidity.

6.5 Caution for operation

-It is an indispensable condition to drive LCD module within the limits of the specified voltage since the higher voltage over the limits may cause the shorter life of LCD module.

-An electrochemical reaction due to DC (direct current) causes LCD undesirable deterioration so that the uses of DC (direct current) drive should be avoided.

-Response time will be extremely delayed at lower temperature than the operating temperature range and on the other hand at higher temperature LCD module may show dark color in them. However those phenomena do not mean malfunction or out of order of LCD module, which will come back in the specified operating temperature.

6.6 Storage

In the case of storing for a long period of time, the following ways are recommended:

- Storage in polyethylene bag with the opening sealed so as not to enter fresh air outside in it. And with not desiccant.
- Placing in a dark place where neither exposure to direct sunlight nor light is. Keeping the storage temperature range.
- Storing with no touch on polarizer surface by any thing else.

6.7 Safety

-It is recommendable to crush damaged or unnecessary LCD into pieces and to wash off liquid crystal by either of solvents such as acetone and ethanol, which should be burned up later.

-When any liquid leaked out of a damaged glass cell comes in contact with your hands, please wash it off well at once with soap and water.

7. Packaging Specifications

	Packaging Specifications HTG12848A	Approved	Checked	Designed

6.1 Packaging Material

No	Item	Dimensions(mm)	IPCS Weight (KG)	Quantity	Total Weight
1	COG	78.7*35.9*2.8	0.016	600	9.6
2	PE Bag	100*60	0.001	600	0.6
3	Foam Rubber Cushion	310*170	0.0175	12	0.21
4	Partition A1	310*170*100	0.30	6	1.8
5	Product Box	330*180*120(neutral packing)	0.45	6	2.7
6	Carton	480*390*330(neutral packing)	1.0	1	1.0
7	Tape			AR	
8	Label Specifications			1	
9	Label Rohs			1	
10	Label ESD			1	

6.2. Total LCD Weight in carton: 15.9 KG±10%

6.3. Packaging Specifications and Quantity:

(1) Quantity Of Spacer: A1*6

(2) Total LCM quantity in carton: quantity per box 100* no of boxes 6 = 600

